

Internet Engineering Task Force (IETF)
Request for Comments: 7406
Category: Informational
ISSN: 2070-1721

H. Schulzrinne
Columbia University
S. McCann
BlackBerry Ltd
G. Bajko
MediaTek
H. Tschofenig

D. Kroeselberg
Siemens Corporate Technology
December 2014

Extensions to the Emergency Services Architecture for Dealing With
Unauthenticated and Unauthorized Devices

Abstract

This document provides a problem statement, introduces terminology, and describes an extension for the base IETF emergency services architecture to address cases where an emergency caller is not authenticated, has no identifiable service provider, or has no remaining credit with which to pay for access to the network.

Status of This Memo

This document is not an Internet Standards Track specification; it is published for informational purposes.

This document is a product of the Internet Engineering Task Force (IETF). It represents the consensus of the IETF community. It has received public review and has been approved for publication by the Internet Engineering Steering Group (IESG). Not all documents approved by the IESG are a candidate for any level of Internet Standard; see Section 2 of RFC 5741.

Information about the current status of this document, any errata, and how to provide feedback on it may be obtained at <http://www.rfc-editor.org/info/rfc7406>.

Copyright Notice

Copyright (c) 2014 IETF Trust and the persons identified as the document authors. All rights reserved.

This document is subject to BCP 78 and the IETF Trust's Legal Provisions Relating to IETF Documents (<http://trustee.ietf.org/license-info>) in effect on the date of publication of this document. Please review these documents carefully, as they describe your rights and restrictions with respect to this document. Code Components extracted from this document must include Simplified BSD License text as described in Section 4.e of the Trust Legal Provisions and are provided without warranty as described in the Simplified BSD License.

Table of Contents

| | |
|--|----|
| 1. Introduction | 3 |
| 2. Terminology | 5 |
| 3. Use-Case Categories | 5 |
| 4. ZBP Considerations | 12 |
| 5. NASP Considerations | 12 |
| 5.1. End-Host Profile | 15 |
| 5.1.1. LoST Server Discovery | 15 |
| 5.1.2. ESRP Discovery | 15 |
| 5.1.3. Location Determination and Location Configuration . . | 15 |
| 5.1.4. Emergency Call Identification | 15 |
| 5.1.5. SIP Emergency Call Signaling | 15 |
| 5.1.6. Media | 16 |
| 5.1.7. Testing | 16 |
| 5.2. IAP/ISP Profile | 16 |
| 5.2.1. ESRP Discovery | 16 |
| 5.2.2. Location Determination and Location Configuration . . | 16 |
| 5.3. ESRP Profile | 16 |
| 5.3.1. Emergency Call Routing | 16 |
| 5.3.2. Emergency Call Identification | 16 |
| 5.3.3. SIP Emergency Call Signaling | 17 |
| 6. Lower-Layer Considerations for NAA Case | 17 |
| 6.1. Link-Layer Emergency Indication | 18 |
| 6.2. Securing Network Attachment in NAA Cases | 19 |
| 7. Security Considerations | 20 |
| 8. References | 21 |
| 8.1. Normative References | 21 |
| 8.2. Informative References | 22 |
| Acknowledgments | 24 |
| Authors' Addresses | 25 |

1. Introduction

Summoning police, the fire department, or an ambulance in emergencies is one of the fundamental and most-valued functions of the telephone. As telephony functionality moves from circuit-switched telephony to Internet telephony, its users rightfully expect that this core functionality will continue to work at least as well as it has for the older technology. New devices and services are being made available that could be used to make a request for help; those devices are not traditional telephones, and users are increasingly expecting them to be able to place emergency calls.

Roughly speaking, the IETF emergency services architecture (see [RFC6881] and [RFC6443]) divides responsibility for handling emergency calls among the access network (Internet Access Provider (IAP) or ISP); the application service provider (ASP), which may be a VoIP service provider (VSP); and the provider of emergency signaling services, the emergency service network (ESN). The access network may provide location information to end systems but does not have to provide any ASP signaling functionality. The emergency caller can reach the ESN either directly or through the ASP's outbound proxy. Any of the three parties can provide the mapping from location to the Public Safety Answering Point (PSAP) URI by offering Location-to-Service Translation (LoST) [RFC5222] services.

In general, a set of automated configuration mechanisms allows a device to function in a variety of architectures, without the user being aware of the details on who provides location, mapping services, or call-routing services. However, if emergency calling is to be supported when the calling device lacks access network authorization or does not have an ASP, one or more of the providers may need to provide additional services and functions.

In all cases, the end device has to be able to perform a LoST lookup and otherwise conduct the emergency call in the same manner as when the three exceptional conditions discussed below do not apply.

We distinguish among three conditions:

No Access Authentication (NAA): In the NAA case, the emergency caller does not possess valid credentials for the access network. This includes the case where the access network allows pay-per-use, as is common for wireless hotspots, but there is insufficient time to enter credit card details and other registration information required for access. It also covers all cases where either no credentials are available at all or the available credentials do not work for the given IAP/ISP. As a result, the NAA case basically combines the No ASP (NASP) and zero-balance ASP (ZBP) cases below, but at the IAP/ISP level. Support for emergency call handling in the NAA case is subject to the local policy of the ISP. Such policy may vary substantially between ISPs and typically depends on external factors that are not under the ISP control.

No ASP (NASP): The caller does not have an ASP at the time of the call. This can occur in case the caller either does not possess any valid subscription for a reachable ASP or does possess a valid subscription but none of the ASPs are reachable through the ISP.

Note: The interoperability need is increased with this scenario since the client software used by the emergency caller must be compatible with the protocols and extensions deployed by the ESN.

Zero-balance ASP (ZBP): In the case of a zero-balance ASP, the ASP can authenticate the caller, but the caller is not authorized to use ASP services, e.g., because the contract has expired or the prepaid account for the customer has been depleted.

These three cases are not mutually exclusive. A caller in need of help may, for example, be both in an NAA and NASP situation, as explained in more detail in Figure 1. Depending on local policy and regulations, it may not be possible to place emergency calls in the NAA case. Unless local regulations require user identification, it should always be possible to place calls in the NASP case, with minimal impact on the ISP. Unless the ESN requires that all calls traverse a known set of Voice Service Providers (VSPs), it is technically possible to let a caller place an emergency call in the ZBP case. We discuss each case in more detail in Section 3.

Some of the functionality provided in this document is already available in the Public Switched Telephone Network (PSTN). Consequently, there is real-world experience available and not all of it is positive. For example, the functionality of calls without Subscriber Identity Modules (SIMs) in today's cellular system has led to a fair amount of hoax or test calls in certain countries.

This causes overload situations at PSAPs, which is considered harmful to the overall availability and reliability of emergency services.

As an example, the Federal Office of Communications (OFCOM, Switzerland) provided statistics about emergency (112) calls in Switzerland from Jan. 1997 to Nov. 2001. Switzerland did not offer SIM-less emergency calls except for almost a month in July 2000 where a significant increase in hoax and test calls was reported. As a consequence, the functionality was disabled again. More details can be found in the panel presentations of the 3rd Standards Development Organization (SDO) Emergency Services Workshop [esw07].

2. Terminology

In this document, the key words "MUST", "MUST NOT", "REQUIRED", "SHALL", "SHALL NOT", "SHOULD", "SHOULD NOT", "RECOMMENDED", "MAY", and "OPTIONAL" are to be interpreted as described in [RFC2119].

This document reuses terminology from [RFC5687] and [RFC5012], namely Internet Access Provider (IAP), Internet Service Provider (ISP), Application Service Provider (ASP), Voice Service Provider (VSP), Emergency Service Routing Proxy (ESRP), Public Safety Answering Point (PSAP), Location Configuration Server (LCS), (emergency) service dial string, and (emergency) service identifier.

3. Use-Case Categories

An end host needs to perform the following steps if it is not attached to the network and the user is starting to place an emergency call:

Link-Layer Attachment: Some networks have added support for unauthenticated emergency access while others have advertised these capabilities using layer beacons (multicast or broadcast announcements). The end host learns about these unauthenticated emergency services capabilities from either the link layer type or advertisement.

The end host uses the link-layer-specific network attachment procedures defined for unauthenticated network access in order to get access to the network.

Pre-emergency Service Configuration: When the link-layer network attachment procedure is completed, the end host learns basic configuration information using DHCP from the ISP. The end host uses a Location Configuration Protocol (LCP) to retrieve location information. Subsequently, the LoST protocol [RFC5222] is used to learn the relevant emergency numbers and to obtain the PSAP URI applicable for that location.

Emergency Call: In case of the need for help, a user dials an emergency number and the SIP User Agent (UA) initiates the emergency call procedures by communicating with the PSAP.

Figure 1 compiles the basic logic taking place during network entry for requesting an emergency service and shows the interrelation between the three conditions described earlier.

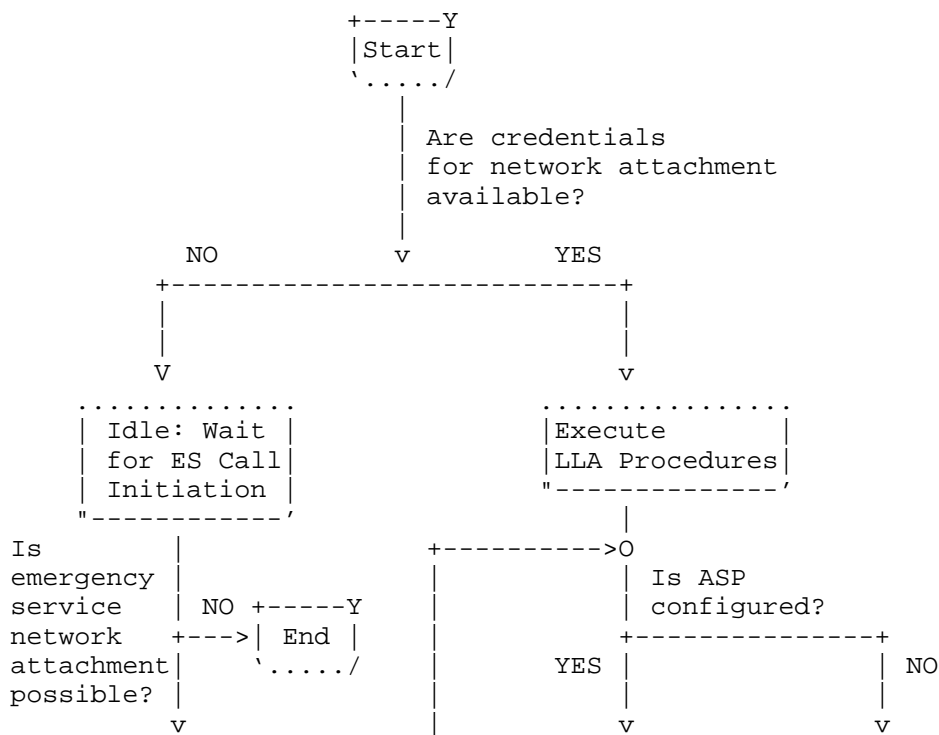

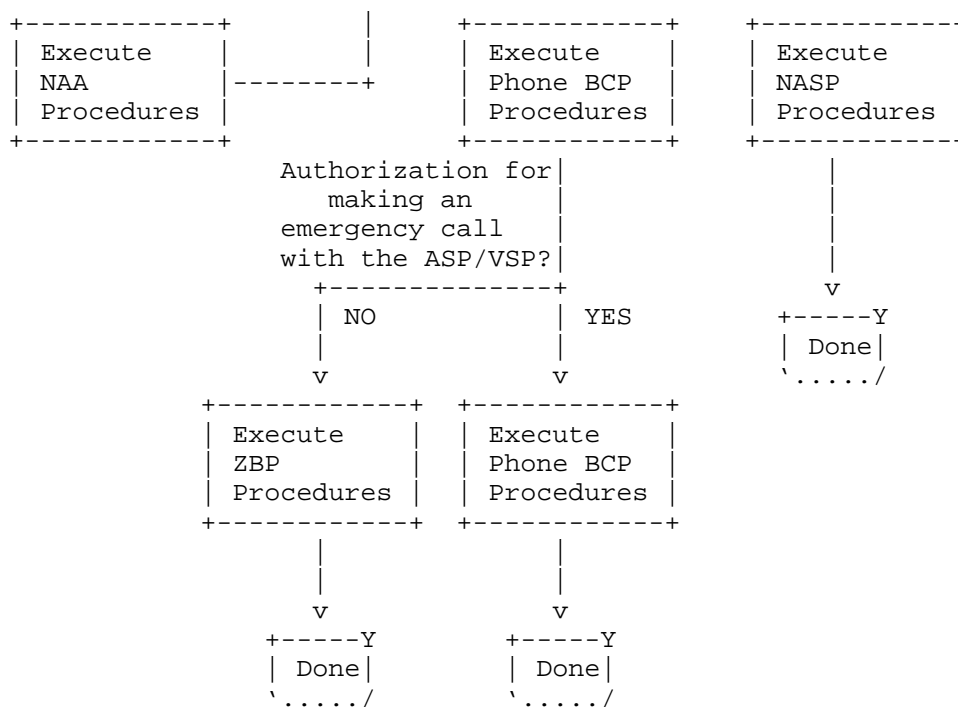

Abbreviations:

LLA: Link-Layer Attachment

ES: Emergency Services

Figure 1: Flow Diagram: NAA, ZBP, and NSAP Scenarios

The diagrams below highlight the most important steps for the three cases.

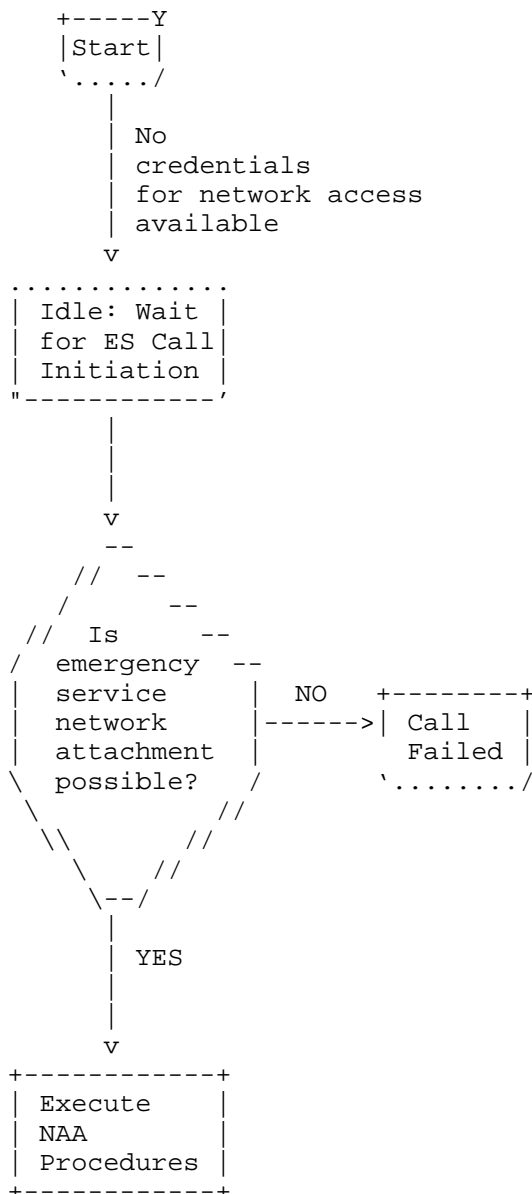

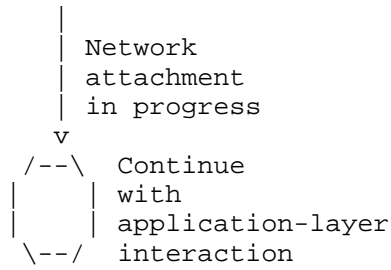
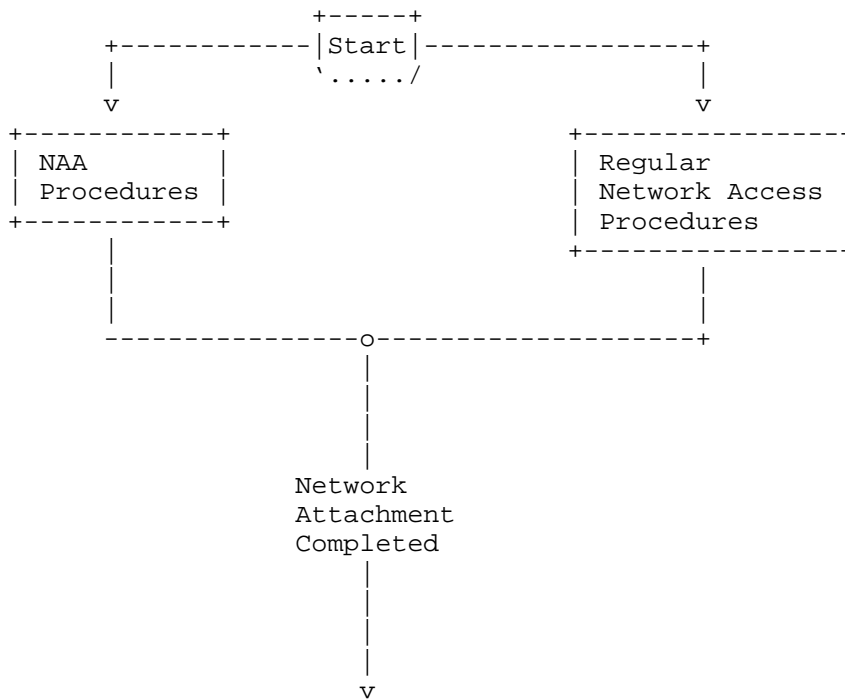

Figure 2: Flow Diagram: NAA Scenario



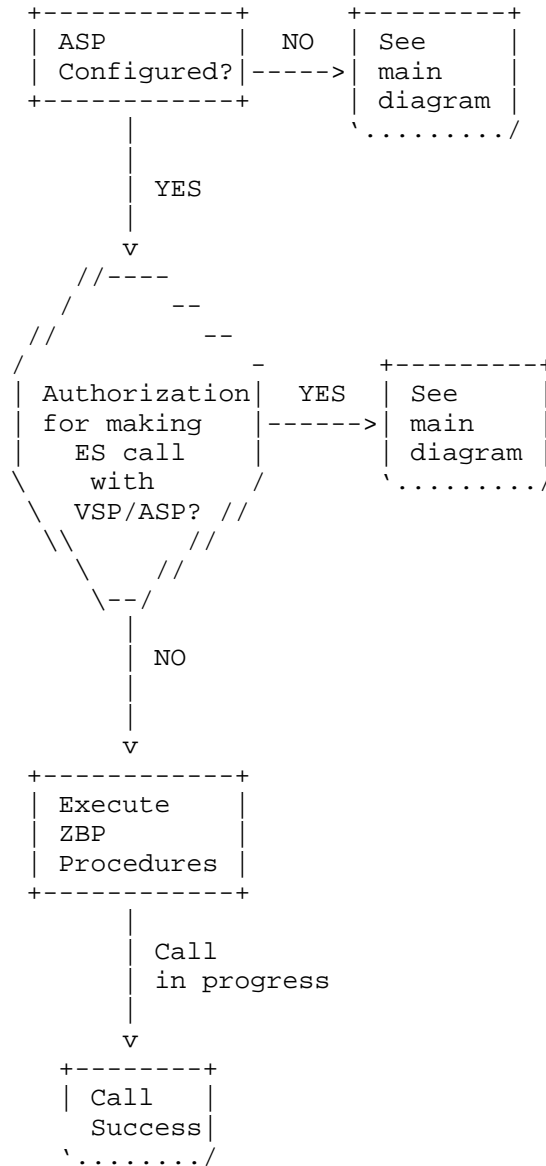

Figure 3: Flow Diagram: ZBP Scenario

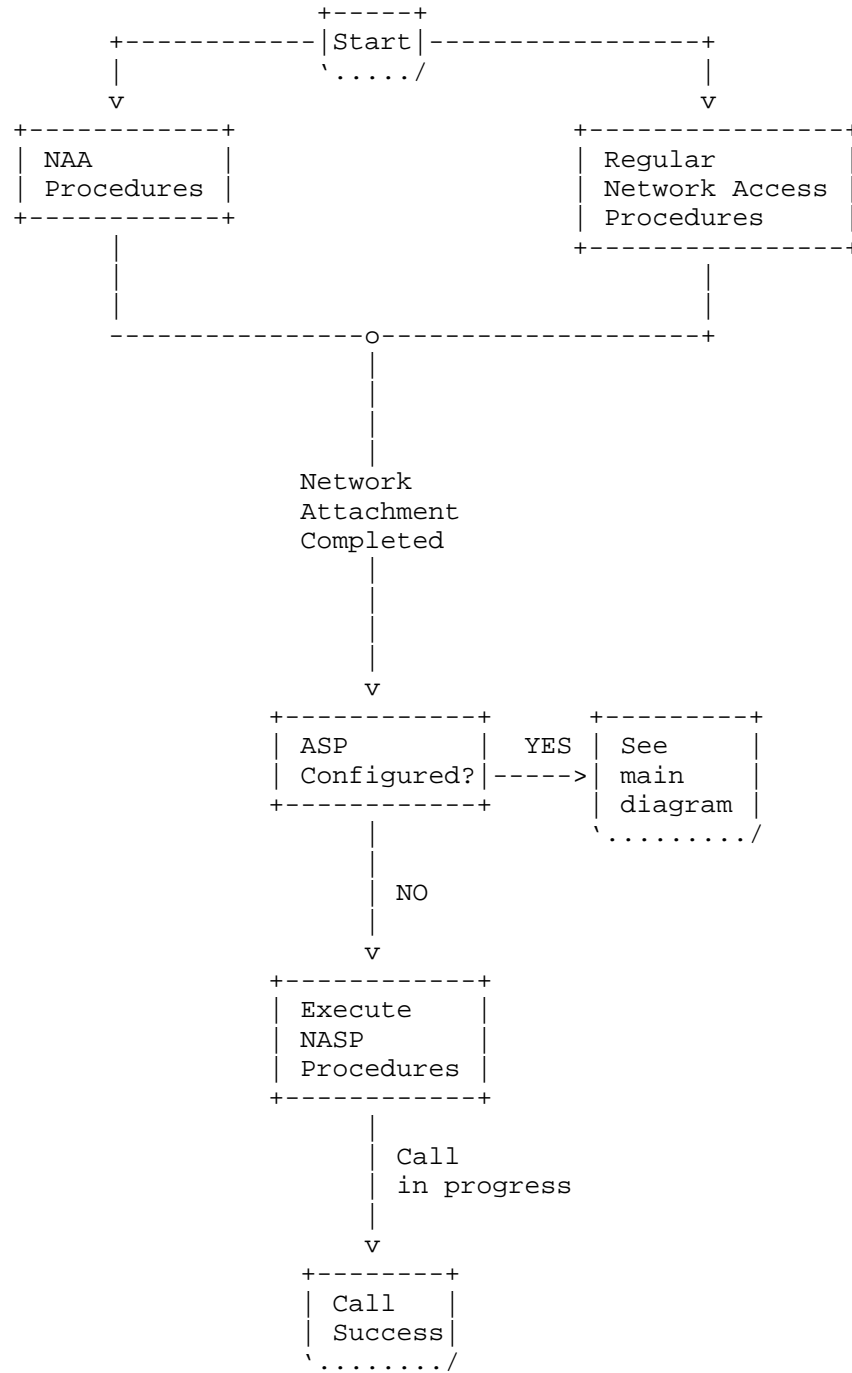

Figure 4: Flow Diagram: NASP Scenario

The NAA procedures are described in Section 6. The ZBP procedures are described in Section 4. The NASP procedures are described in Section 5. The Phone BCP procedures are described in [RFC6881]. The LLA procedures are not described in this document since they are specific to the link-layer technology in use.

4. ZBP Considerations

ZBP includes all cases where a subscriber is known to an ASP but lacks the necessary authorization to access regular ASP services. Example ZBP cases include empty prepaid accounts, barred accounts, roaming and mobility restrictions, or any other conditions set by ASP policy.

Local regulation might demand that emergency calls cannot proceed without successful service authorization. In some regulatory regimes, however, it may be possible to allow emergency calls to continue despite authorization failures. To distinguish an emergency call from a regular call, an ASP can identify emergency sessions by inspecting the service URN [RFC5031] used in call setup. The ZBP case, therefore, only affects the ASP.

Permitting a call despite authorization failures could present an opportunity for abuse. The ASP may choose to verify the destination of the emergency calls and to only permit calls to certain, preconfigured entities (e.g., to local PSAPs). Section 7 discusses this topic in more detail.

An ASP without a regulatory requirement to authorize emergency calls can deny emergency call setup. Where an ASP does not authorize an emergency call, the caller may be able to fall back to NASP procedures.

5. NASP Considerations

To start the description, we consider the sequence of steps that are executed in an emergency call based on Figure 5.

- o As an initial step, the devices attach to the network as shown in step (1). This step is outside the scope of this section.
- o When the link-layer network attachment procedure is completed, the end host learns basic IP configuration information using DHCP from the ISP, as shown in step (2).

- o When the end host has configured the IP address, it starts an interaction with the discovered LCS at the ISP, as shown in step (3). In certain deployments, the ISP may need to interact with the IAP. This protocol exchange is shown in step (4).
- o Once location information is obtained, the end host triggers the LoST protocol to obtain the address of the ESRP/PSAP. This is shown in step (5).
- o In step (6), the SIP UA initiates a SIP INVITE request towards the indicated ESRP. The INVITE message contains all the necessary parameters required by Section 5.1.5.
- o The ESRP receives the INVITE and processes it according to the description in Section 5.3.3.
- o The ESRP routes the call to the PSAP, as shown in step (8), potentially interacting with a LoST server first to determine the route.
- o The PSAP evaluates the initial INVITE and aims to complete the call setup.
- o Finally, when the call setup is completed, media traffic can be exchanged between the PSAP and the SIP UA.

For brevity, the end-to-end SIP and media exchange between the PSAP and SIP UA are not shown in Figure 5.

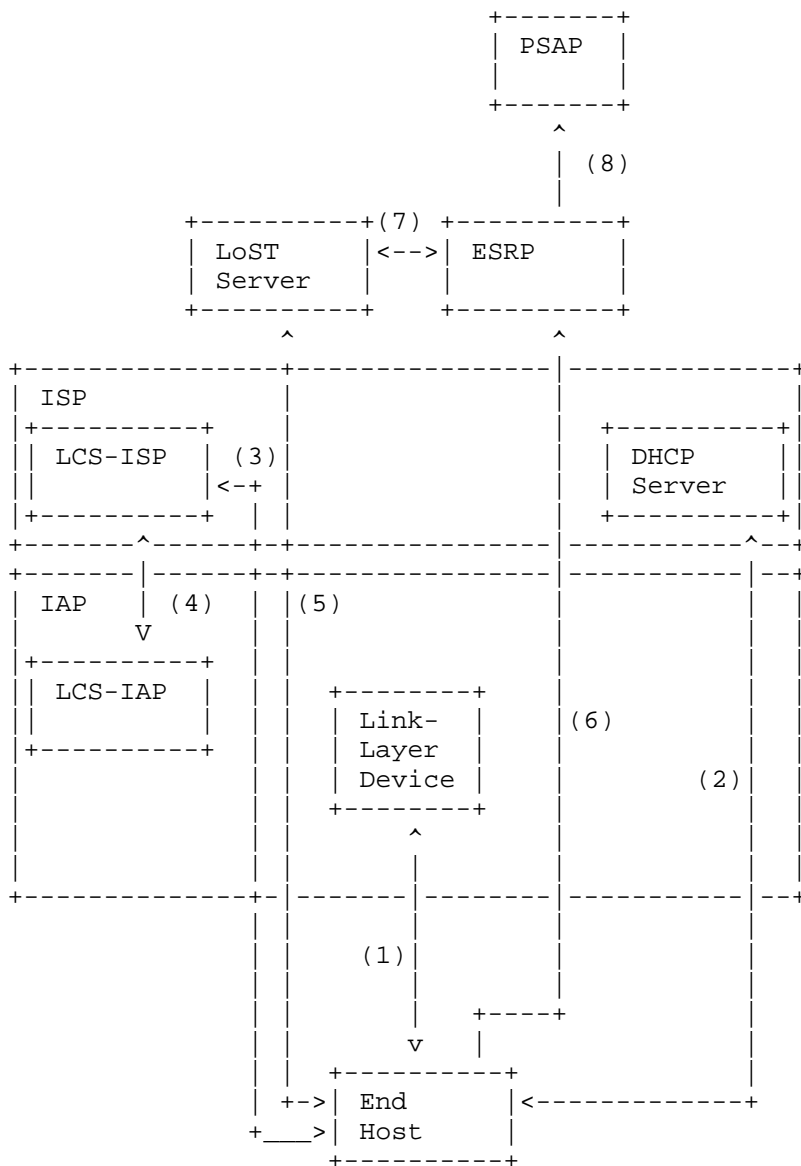

Figure 5: Architectural Overview

Note: Figure 5 does not indicate who operates the ESRP and the LoST server. Various deployment options exist.

5.1. End-Host Profile

5.1.1. LoST Server Discovery

The end host MUST discover a LoST server [RFC5222] using DHCP [RFC5223] unless a LoST server has been provisioned using other means.

5.1.2. ESRP Discovery

The end host MUST discover the ESRP using the LoST protocol [RFC5222] unless a ESRP has been provisioned using other means.

5.1.3. Location Determination and Location Configuration

The end host MUST support location acquisition and the LCPs described in Section 6.5 of [RFC6881]. The description in Sections 6.5 and 6.6 of [RFC6881] regarding the interaction between the device and the Location Information Server (LIS) applies to this document.

The SIP UA in the end host MUST attach available location information in a Presence Information Data Format Location Object (PIDF-LO) [RFC4119] when making an emergency call. When constructing the PIDF-LO, the guidelines in the PIDF-LO profile [RFC5491] MUST be followed. For civic location information, the format defined in [RFC5139] MUST be supported.

5.1.4. Emergency Call Identification

To determine which calls are emergency calls, some entity needs to map a user-entered dial string into this URN scheme. A user may "dial" 1-1-2, 9-1-1, etc., but the call would be sent to urn:service:sos. This mapping SHOULD be performed at the endpoint device.

End hosts MUST use the Service URN mechanism [RFC5031] to mark calls as emergency calls for their home emergency dial string.

5.1.5. SIP Emergency Call Signaling

SIP signaling capabilities [RFC3261] are REQUIRED for end hosts.

The initial SIP signaling method is an INVITE. The SIP INVITE request MUST be constructed according to the requirements in Section 9.2 of [RFC6881].

To enable callbacks, SIP UAs SHOULD place a globally routable URI in a Contact header field.

5.1.6. Media

Endpoints MUST comply with the media requirements for endpoints placing an emergency call as described in Section 14 of [RFC6881].

5.1.7. Testing

The description in Section 15 of [RFC6881] is fully applicable to this document.

5.2. IAP/ISP Profile

5.2.1. ESRP Discovery

An ISP MUST provision a DHCP server with information about LoST servers [RFC5223]. An ISP operator may choose to deploy a LoST server or to outsource it to other parties.

5.2.2. Location Determination and Location Configuration

The ISP is responsible for location determination and exposes this information to the endpoints via location configuration protocols. The considerations described in [RFC6444] are applicable to this document.

The ISP MUST support one of the LCPs described in Section 6.5 of [RFC6881]. The description in Sections 6.5 and 6.6 of [RFC6881] regarding the interaction between the end device and the LIS applies to this document.

The interaction between the LIS at the ISP and the IAP is often proprietary, but the description in [LIS] may be relevant to the reader.

5.3. ESRP Profile

5.3.1. Emergency Call Routing

The ESRP continues to route the emergency call to the PSAP responsible for the physical location of the end host. This may require further interactions with LoST servers but depends on the specific deployment.

5.3.2. Emergency Call Identification

The ESRP MUST understand the Service URN mechanism [RFC5031] (i.e., the 'urn:service:sos' tree).

5.3.3. SIP Emergency Call Signaling

SIP signaling capabilities [RFC3261] are REQUIRED for the ESRP. The ESRP MUST process the messages sent by the client, according to Section 5.1.5.

Furthermore, if a PSAP wants to support NASP calls, then it MUST NOT restrict incoming calls to a particular set of ASPs.

6. Lower-Layer Considerations for NAA Case

Some networks have added support for unauthenticated emergency access while others have advertised these capabilities using layer beacons. The end host learns about these unauthenticated emergency services capabilities either from the link-layer type or from advertisement.

It is important to highlight that the NAA case is inherently a Layer 2 problem, and the general form of the solution is to provide an "emergency only" access type, with appropriate limits or monitoring to prevent abuse. The described mechanisms are informative in nature since the relationship to the IETF emergency services architecture is only indirect, namely via some protocols developed within the IETF (e.g., EAP and EAP methods) that require extensions to support this functionality.

This section discusses different methods to indicate an emergency service request as part of network attachment. It provides some general considerations and recommendations that are not specific to the access technology.

To perform network attachment and get access to the resources provided by an IAP/ISP, the end host uses access technology-specific network attachment procedures, including, for example, network detection and selection, authentication, and authorization. For initial network attachment of an emergency service requester, the method of how the emergency indication is given to the IAP/ISP is specific to the access technology. However, a number of general approaches can be identified:

Link-layer emergency indication: The end host provides an indication, e.g., an emergency parameter or flag, as part of the link-layer signaling for initial network attachment. Examples include an emergency bit signaled in the IEEE 802.16-2009 wireless link. In IEEE 802.11 WLAN [IEEE802.11], an emergency support indicator allows the station (i.e., end host in this context) to download before association to a Network Access Identifier (NAI), which it can use to request server-side authentication only for an IEEE 802.1X network.

Higher-layer emergency indication: Typically, emergency indication is provided in the network access authentication procedure. The emergency caller's end host provides an indication as part of the access authentication exchanges. Authentication via the EAP [RFC3748] is of particular relevance here. Examples are the EAP NAI decoration used in Worldwide Interoperability for Microwave Access (WiMAX) networks and modification of the authentication exchange in IEEE 802.11 [nwgstg3].

6.1. Link-Layer Emergency Indication

In general, link-layer emergency indications provide good integration into the actual network access procedure regarding the enabling of means to recognize and prioritize an emergency service request from an end host at a very early stage of the network attachment procedure. However, support in end hosts for such methods cannot be considered to be commonly available.

No general recommendations are given in the scope of this memo due to the following reasons:

- o Dependency on the specific access technology.
- o Dependency on the specific access network architecture. Access authorization and policy decisions typically happen at different layers of the protocol stack and in different entities than those terminating the link-layer signaling. As a result, link-layer indications need to be distributed and translated between the different protocol layers and entities involved. Appropriate methods are specific to the actual architecture of the IAP/ISP network.
- o An advantage of combining emergency indications with the actual network attachment procedure performing authentication and authorization is the fact that the emergency indication can directly be taken into account in the authentication and authorization server that owns the policy for granting access to the network resources. As a result, there is no direct dependency on the access network architecture that otherwise would need to take care of merging link-layer indications into the authentication, authorization, and policy decision process.
- o EAP signaling happens at a relatively early stage of network attachment, so it is likely to match most requirements for prioritization of emergency signaling. However, it does not cover

early stages of link-layer activity in the network attachment process. Possible conflicts may arise, e.g., in case of filtering based on Media Access Control (MAC) in entities terminating link-layer signaling in the network (like a base station). In normal operation, EAP-related information will only be recognized in the Network Access Server (NAS). Any entity residing between the end host and NAS should not be expected to understand/parse EAP messages.

- o An emergency indication can be given by forming a specific NAI that is used as the identity in EAP-based authentication for network entry.

6.2. Securing Network Attachment in NAA Cases

For network attachment in NAA cases, it may make sense to secure the link-layer connection between the device and the IAP/ISP. This especially holds for wireless access with examples being access based on IEEE 802.11 or IEEE 802.16. The latter even mandates secured communication across the wireless link for all IAP/ISP networks based on [nwgstg3].

Therefore, for network attachment that is by default based on EAP authentication, it is desirable also for NAA network attachment to use a key-generating EAP method (that provides a Master Session Key (MSK) to the authenticator to bootstrap further key derivation for protecting the wireless link).

To match the above, the following approaches can be identified:

1) Server-Only Authentication:

The device of the emergency service requester performs an EAP method with the IAP/ISP EAP server that performs server-side authentication only. An example for this is EAP-TLS [RFC5216]. This provides a certain level of assurance about the IAP/ISP to the device user. It requires the device to be provisioned with appropriate trusted root certificates to be able to verify the server certificate of the EAP server (unless this step is explicitly skipped in the device in case of an emergency service request). This method is used to provide access of devices without existing credentials to an IEEE 802.1X network. The details are incorporated in the IEEE 802.11-2012 specification [IEEE802.11].

2) Null Authentication:

In one case (e.g., WiMAX), an EAP method is performed. However, no credentials specific to either the server or the device or subscription are used as part of the authentication exchange. An example for this would be an EAP-TLS exchange using the TLS_DH_anon (anonymous) ciphersuite. Alternatively, a publicly available static key for emergency access could be used. In the latter case, the device would need to be provisioned with the appropriate emergency key for the IAP/ISP in advance. In another case (e.g., IEEE 802.11), no EAP method is used, so that empty frames are transported during the over-the-air IEEE 802.1X exchange. In this case, the authentication state machine completes with no cryptographic keys being exchanged.

3) Device Authentication:

This case extends the server-only authentication case. If the device is configured with a device certificate and the IAP/ISP EAP server can rely on a trusted root allowing the EAP server to verify the device certificate, at least the device identity (e.g., the MAC address) can be authenticated by the IAP/ISP in NAA cases. An example for this is WiMAX devices that are shipped with device certificates issued under the global WiMAX device public-key infrastructure. To perform unauthenticated emergency calls, if allowed by the IAP/ISP, such devices perform network attachment based on EAP-TLS with client authentication based on the device certificate.

7. Security Considerations

The security threats discussed in [RFC5069] are applicable to this document.

The NASP and NAA cases introduce new vulnerabilities since the PSAP operator will typically not have any information about the identity of the caller via the signaling path. Today, in countries where this functionality is used for Global System for Mobile Communications (GSM) networks, this has led to a significant amount of misuse.

In the context of NAA, the IAP and the ISP will probably want to make sure that the claimed emergency caller indeed performs an emergency call rather than using the network for other purposes, and thereby acting fraudulent by skipping any authentication, authorization, and accounting procedures. By restricting access of the unauthenticated emergency caller to the LoST server and the PSAP URI, traffic can be restricted only to emergency calls. This can be accomplished with traffic separation. However, the details, e.g., for using filtering,

depend on the deployed ISP architecture and are beyond the scope of this document.

We only illustrate a possible model. If the ISP runs its own (caching) LoST server, the ISP would maintain an access control list populated with IP-address information obtained from LoST responses (in the mappings). These URIs would either be URIs for contacting further LoST servers or PSAP URIs. It may be necessary to translate domain names returned in LoST responses to IP addresses. Since the media destination addresses are not predictable, the ISP also has to provide a SIP outbound proxy so that it can determine the media addresses and add those to the filter list.

For the ZBP case, the additional aspect of fraud has to be considered. Unless the emergency call traverses a PSTN gateway or the ASP charges for IP-to-IP calls, there is little potential for fraud. If the ASP also operates the LoST server, the outbound proxy MAY restrict outbound calls to the SIP URIs returned by the LoST server. It is NOT RECOMMENDED to rely on a fixed list of SIP URIs, as that list may change.

RFC 6280 [RFC6280] discusses security vulnerabilities that are caused by an adversary faking location information and thereby lying about the actual location of the emergency caller. These threats may be less problematic in the context of an unauthenticated emergency when location information can be verified by the ISP to fall within a specific geographical area.

8. References

8.1. Normative References

- [RFC2119] Bradner, S., "Key words for use in RFCs to Indicate Requirement Levels", BCP 14, RFC 2119, March 1997, <<http://www.rfc-editor.org/info/rfc2119>>.
- [RFC3261] Rosenberg, J., Schulzrinne, H., Camarillo, G., Johnston, A., Peterson, J., Sparks, R., Handley, M., and E. Schooler, "SIP: Session Initiation Protocol", RFC 3261, June 2002, <<http://www.rfc-editor.org/info/rfc3261>>.
- [RFC4119] Peterson, J., "A Presence-based GEOPRIV Location Object Format", RFC 4119, December 2005, <<http://www.rfc-editor.org/info/rfc4119>>.
- [RFC5031] Schulzrinne, H., "A Uniform Resource Name (URN) for Emergency and Other Well-Known Services", RFC 5031, January 2008, <<http://www.rfc-editor.org/info/rfc5031>>.

- [RFC5139] Thomson, M. and J. Winterbottom, "Revised Civic Location Format for Presence Information Data Format Location Object (PIDF-LO)", RFC 5139, February 2008, <<http://www.rfc-editor.org/info/rfc5139>>.
- [RFC5222] Hardie, T., Newton, A., Schulzrinne, H., and H. Tschofenig, "LoST: A Location-to-Service Translation Protocol", RFC 5222, August 2008, <<http://www.rfc-editor.org/info/rfc5222>>.
- [RFC5223] Schulzrinne, H., Polk, J., and H. Tschofenig, "Discovering Location-to-Service Translation (LoST) Servers Using the Dynamic Host Configuration Protocol (DHCP)", RFC 5223, August 2008, <<http://www.rfc-editor.org/info/rfc5223>>.
- [RFC5491] Winterbottom, J., Thomson, M., and H. Tschofenig, "GEOPRIV Presence Information Data Format Location Object (PIDF-LO) Usage Clarification, Considerations, and Recommendations", RFC 5491, March 2009, <<http://www.rfc-editor.org/info/rfc5491>>.
- [RFC6881] Rosen, B. and J. Polk, "Best Current Practice for Communications Services in Support of Emergency Calling", BCP 181, RFC 6881, March 2013, <<http://www.rfc-editor.org/info/rfc6881>>.

8.2. Informative References

- [IEEE802.11] IEEE, "IEEE Standard for Information Technology - Telecommunications and information exchange between systems - Local and metropolitan area networks - Specific requirements Part 11: Wireless LAN Medium Access Control (MAC) and Physical Layer (PHY) Specifications", IEEE Std 802.11-2012, March 2012, <<http://standards.ieee.org/about/get/802/802.11.html>>.
- [LIS] Winterbottom, J. and S. Norreys, "LIS to LIS Protocol Requirements", Work in Progress, draft-winterbottom-geopriv-lis2lis-req-01, November 2007.
- [RFC3748] Aboba, B., Blunk, L., Vollbrecht, J., Carlson, J., and H. Levkowitz, "Extensible Authentication Protocol (EAP)", RFC 3748, June 2004, <<http://www.rfc-editor.org/info/rfc3748>>.

- [RFC5012] Schulzrinne, H. and R. Marshall, "Requirements for Emergency Context Resolution with Internet Technologies", RFC 5012, January 2008, <<http://www.rfc-editor.org/info/rfc5012>>.
- [RFC5069] Taylor, T., Tschofenig, H., Schulzrinne, H., and M. Shanmugam, "Security Threats and Requirements for Emergency Call Marking and Mapping", RFC 5069, January 2008, <<http://www.rfc-editor.org/info/rfc5069>>.
- [RFC5216] Simon, D., Aboba, B., and R. Hurst, "The EAP-TLS Authentication Protocol", RFC 5216, March 2008, <<http://www.rfc-editor.org/info/rfc5216>>.
- [RFC5687] Tschofenig, H. and H. Schulzrinne, "GEOPRIV Layer 7 Location Configuration Protocol: Problem Statement and Requirements", RFC 5687, March 2010, <<http://www.rfc-editor.org/info/rfc5687>>.
- [RFC6280] Barnes, R., Lepinski, M., Cooper, A., Morris, J., Tschofenig, H., and H. Schulzrinne, "An Architecture for Location and Location Privacy in Internet Applications", BCP 160, RFC 6280, July 2011, <<http://www.rfc-editor.org/info/rfc6280>>.
- [RFC6443] Rosen, B., Schulzrinne, H., Polk, J., and A. Newton, "Framework for Emergency Calling Using Internet Multimedia", RFC 6443, December 2011, <<http://www.rfc-editor.org/info/rfc6443>>.
- [RFC6444] Schulzrinne, H., Liess, L., Tschofenig, H., Stark, B., and A. Kuett, "Location Hiding: Problem Statement and Requirements", RFC 6444, January 2012, <<http://www.rfc-editor.org/info/rfc6444>>.
- [esw07] "3rd Standards Development Organizations (SDO) Emergency Services Workshop", October 30th - November 1st 2007, <<http://www.emergency-services-coordination.info/2007Nov/>>.
- [nwgstg3] WiMAX Forum, "WiMAX Forum Network Architecture - Detailed Protocols and Procedures Base Specification", Stage-3 WMF-T33-001-R022V02, April 2014, <http://resources.wimaxforum.org/sites/wimaxforum.org/files/technical_document/2014/05/WMF-T33-001-R022v02_Network-Stage3-Base.pdf>.

Acknowledgments

Parts of this document are derived from [RFC6881]. Participants of the 2nd and 3rd SDO Emergency Services Workshop provided helpful input.

We would like to thank Richard Barnes, Marc Linsner, James Polk, Brian Rosen, and Martin Thomson for their feedback at the IETF#80 Emergency Context Resolution with Internet Technology (ECRIT) meeting.

Furthermore, we would like to thank Martin Thomson and Bernard Aboba for their detailed document review in preparation of the 81st IETF meeting. Alexey Melnikov was the General Area (Gen-Art) reviewer. A number of changes to the document had been made in response to the AD review by Richard Barnes.

Various IESG members provided review comments, including Spencer Dawkins, Stephen Farrell, Joel Jaeggli, Barry Leiba, Ted Lemon, and Pete Resnick.

Authors' Addresses

Henning Schulzrinne
Columbia University
Department of Computer Science
450 Computer Science Building
New York, NY 10027
United States

Phone: +1 212 939 7004
EMail: hgs+ecrit@cs.columbia.edu
URI: <http://www.cs.columbia.edu>

Stephen McCann
BlackBerry Ltd
200 Bath Road
Slough, Berks SL1 3XE
United Kingdom

Phone: +44 1753 667099
EMail: smccann@blackberry.com
URI: <http://www.blackberry.com>

Gabor Bajko
MediaTek

EMail: gabor.bajko@mediatek.com

Hannes Tschofenig
Hall in Tirol 6060
Austria

EMail: Hannes.Tschofenig@gmx.net
URI: <http://www.tschofenig.priv.at>

Dirk Kroeselberg
Siemens Corporate Technology
Otto-Hahn-Ring 6
Munich 81739
Germany

EMail: dirk.kroeselberg@siemens.com